

ESD/Surge Protection Diode in DFN1610

Features

- 1600 Watts peak pulse power ($t_p = 8/20\mu s$)
- DFN1610 package
- Unidirectional configurations
- Solid-state silicon-avalanche technology
- Low clamping voltage
- Low leakage current
- Normal capacitance ($C_j=500pF$)
- Protection one data/power line to:
 - IEC 61000-4-2 $\pm 30kV$ contact $\pm 30kV$ air
 - IEC 61000-4-4 (EFT) 55A (5/50ns)
 - IEC 61000-4-5 (Lightning) 45A (8/20 μs)

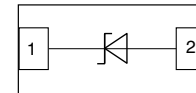
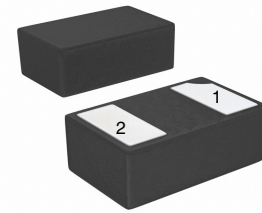

Mechanical Data

- **Case:** DFN1610 (plastic package)
Lead free; RoHS compliant
- **Molding Compound Flammability Rating:**
UL 94 V-0
- **Terminals:** High temperature soldering guaranteed:
260 °C/10 sec. at terminals

Applications

- Charger Protection
- Parallel & Serial Port Protection
- Personal Digital Assistant (PDA)
- Microcontroller Input Protection
- Cellular Phones
- I²C Bus Protection

Absolute Maximum Ratings

Ratings at 25 °C, ambient temperature unless otherwise specified

Parameter	Symbol	Value	Unit
Peak Pulse Power ($T_p=8/20\mu s$)	P_{PP}	1500	W
ESD contact/air discharge (IEC-61000-4-2)	V_{ESD}	30/30	kV
Peak Pulse Current ($t_p = 8/20\mu s$)	I_{PP}	45	A
Junction Temperature	T_J	-40 to +125	°C
Storage temperature	T_{STG}	-55 to +150	°C

Electrical Characteristics

($T_A = 25\text{ °C}$ unless otherwise specified)

Parameter	Symbol	Condition	Min	Typ	Max	Unit
Reverse stand-off Voltage	V_{RWM}				15	V
Reverse Breakdown Voltage	V_{BR}	$I_T=1mA$	16.5			V
Reverse Leakage Current	I_R	$V_R=15V$			1	μA
Clamping Voltage (IEC 61000-4-5)	V_C	$I_{PP}=1A$			20	V
Clamping Voltage (IEC 61000-4-5)	V_C	$I_{PP}=20A$			25.5	V
Clamping Voltage (IEC 61000-4-5)	V_C	$I_{PP}=45A$			34	V
Junction Capacitance	C_J	$V_R=0V, f=1MHz$		500		pF

Typical Characteristics ($T_{amb} = 25\text{ }^{\circ}\text{C}$ unless otherwise specified)

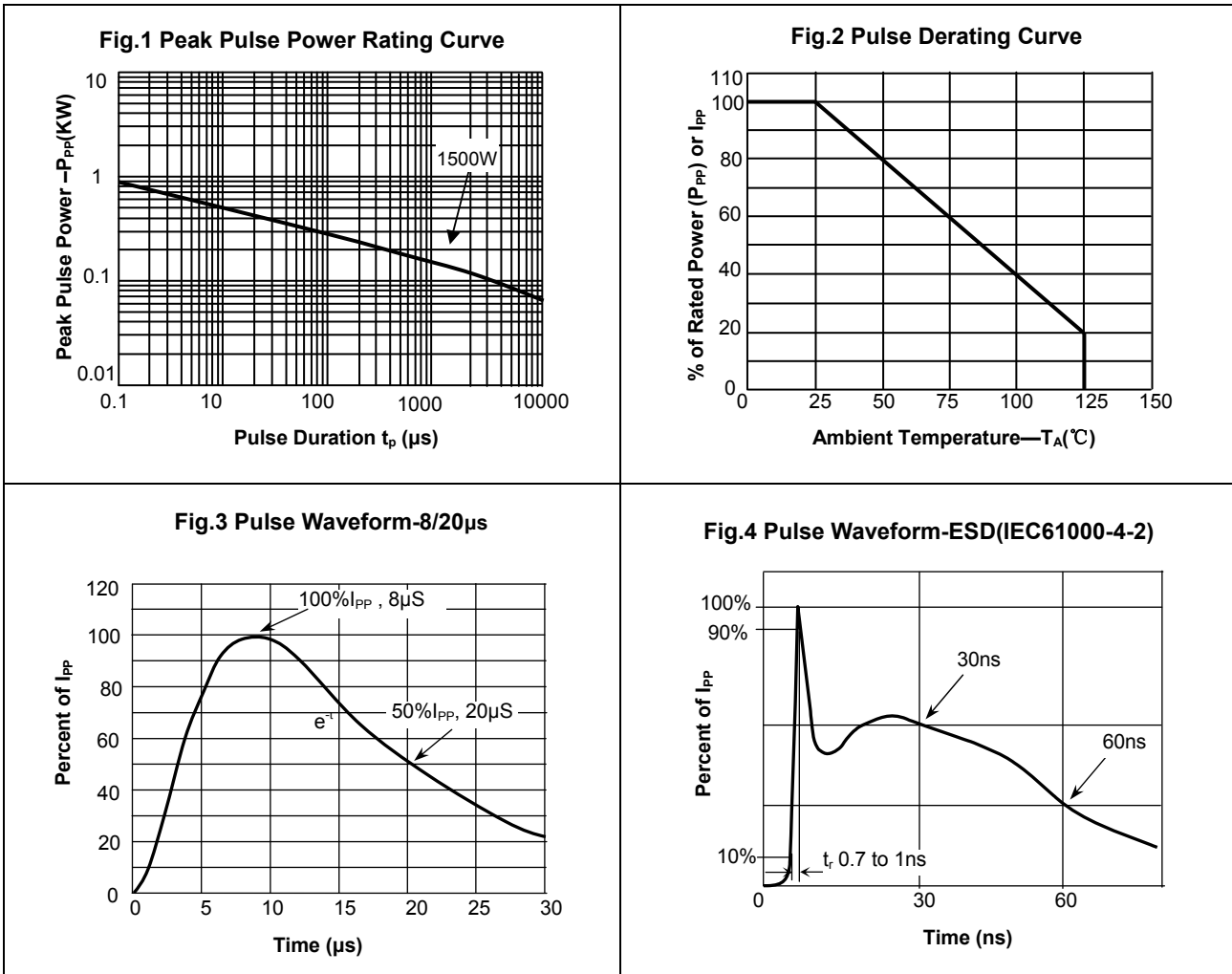

Package Dimensions

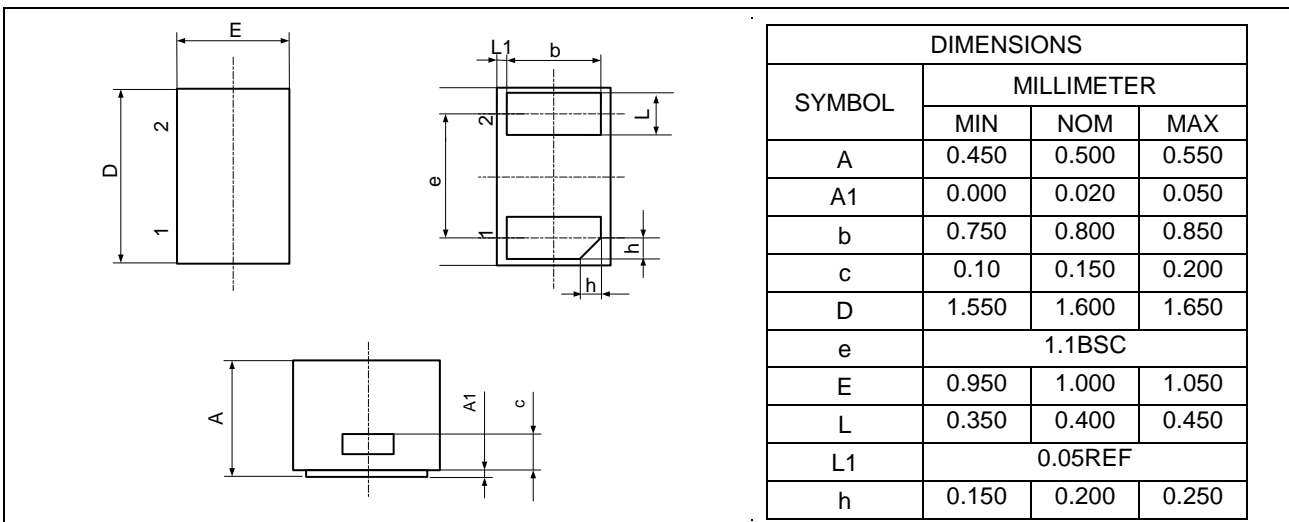

Pad Dimensions

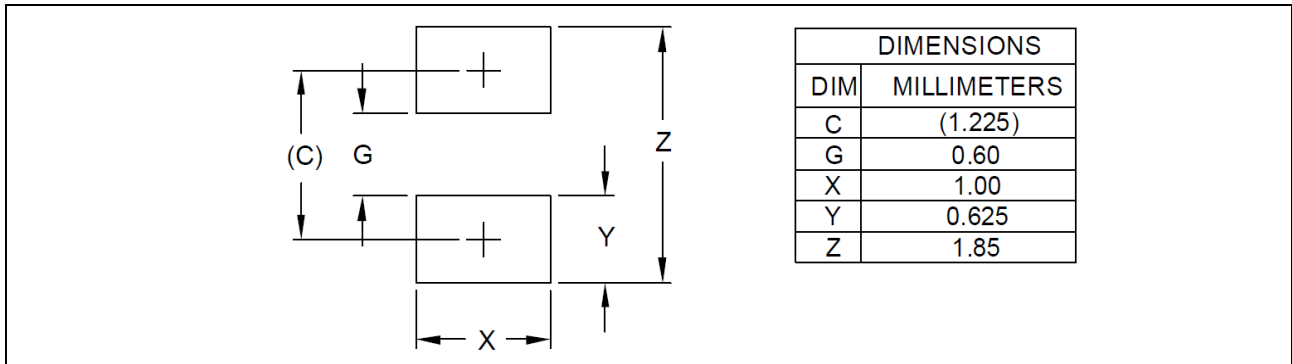

Part number system

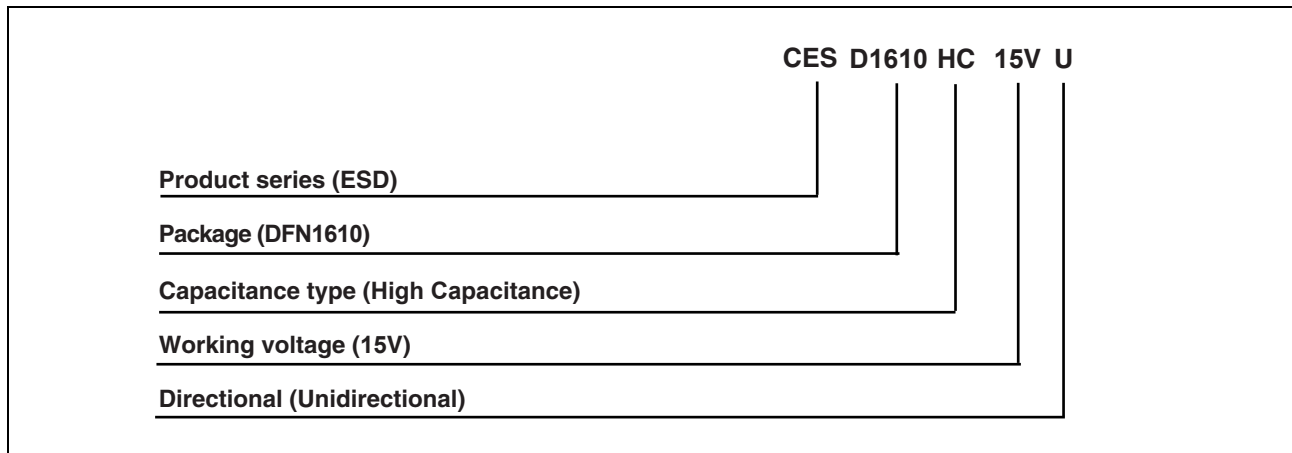

Ordering information

Order code	Marking	Package	Packaging option	Base quantity	Weight	Packaging specification
CESD1610HC15VU	UTC	DFN1610	Tape and reel	3000pcs / reel	3.5mg	EIA STD RS-481

Revision history

Date	Revision	Changes
23-May-2012	1.0	Initial release

CAUTION / WARNING

Information in this document is believed to be accurate and reliable. However, CREATEK does not give any representations or warranties, expressed or implied, as to the accuracy or completeness of such information and shall have no liability for the consequences of use of such information.

Users should independently evaluate the suitability of and test each product selected for their own applications, and CREATEK assumes no liability whatsoever relating to the choice, selection or use of the CREATEK products and services described herein.

CREATEK reserves the right to change or update, without notice, any information contained in this publication; to change, without notice, the design, construction, processing, or specification of any product; and to discontinue or limit production or distribution of any product.

Information in this document supersedes and replaces all information previously supplied.

Products are not designed, authorized or warranted to be suitable for use in medical, military, aircraft, space or life support equipment, nor in applications where failure or malfunction of an CREATEK product can reasonably be expected to result in personal injury, death or severe property or environmental damage. CREATEK accepts no liability for inclusion and/or use of CREATEK products in such equipment or applications and therefore such inclusion and/or use is at the customer's own risk.

This document as well as the item(s) described herein may be subject to export control regulations. Export might require a prior authorization from national authorities.

Resale of CREATEK products with provisions different from the statements and/or technical features set forth in this document shall immediately void any warranty granted by CREATEK for the CREATEK product or service described herein and shall not create or extend in any manner whatsoever, any liability of CREATEK.

CREATEK expressly disclaims all implied warranties regarding the information contained herein, including, but not limited to, any implied warranties of merchantability or fitness for a particular purpose. CREATEK only obligations are those in the CREATEK Standard Terms and Conditions of Sale and in no case will CREATEK be liable for any incidental, indirect, or consequential damages arising from the sale, resale, use, or misuse of its products.

Specifications are subject to change without notice

© Copyright 2009, CREATEK Microelectronics

 CREATEK® is a registered trademark of CREATEK Microelectronics

All rights reserved