

## Ultra Low Capacitance ESD Protection Diode in 2510

### Features

- ESD protection for high speed data lines to IEC61000-4-2
- ESD contact discharge typical 15KV, max 30KV
- ESD air discharge typical 25KV, max 30KV
- Surface mount
- Extremely low capacitance
- Very low leakage current
- Fast response time
- Bi-directional ESD protection
- Lead free solder termination
- The best ESD protection for high frequency, low voltage applications

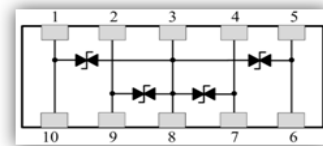
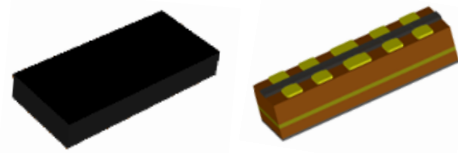

### Mechanical Data

- **Case:** 2510 (plastic package).  
Lead free; RoHS compliant
- **Molding Compound Flammability Rating:**  
UL 94 V-0
- **Terminals:** High temperature soldering guaranteed:  
260 °C/10 sec. at terminals

### Applications

- USB3.0, Firewire, DVI, HDMI, S-ATA
- Thunderbolt, Display Port
- Mobile HDMI Link, MDDI, MIPI, SWP / NFC
- Unified Display Interface (UDI)
- IEEE1394 interface
- Gigabit Ethernet

### Absolute Maximum Ratings

Ratings at 25 °C, ambient temperature unless otherwise specified

Parameter	Symbol	Value	Units
Maximum Contact discharge voltage Per IEC61000-4-2	---	30KV	V
Maximum Air discharge voltage Per IEC61000-4-2	---	30KV	V
Maximum Operating temperature	T <sub>OPER</sub>	-40 to +125	°C
Maximum Storage temperature	T <sub>STG</sub>	-55 to +125	°C
Maximum lead temperature for soldering during 10s	T <sub>L</sub>	260	°C

### Electrical Characteristics

(T<sub>A</sub> = 25 °C unless otherwise specified)

Parameter	Symbol	Test Conditions	Min	Typ	Max	Units
Rated Voltage	V <sub>R</sub>	---	---	---	5	V
Trigger voltage	V <sub>T</sub>	IEC61000-4-2 8KV contact discharge	---	350	---	V
Clamping voltage	V <sub>C</sub>	IEC61000-4-2 8KV contact discharge	---	35	---	V
Leakage current	I <sub>L</sub>	DC 12V shall be applied on component	---		0.10	uA
Capacitance	C <sub>P</sub>	V <sub>R</sub> = 0V, f = 1MHz	---	0.05	0.1	pF

Note: 1. Trigger and clamping voltage are measured per IEC 61000-4-2, 8KV contact discharge method.  
2. After reliability tests such as high temp storage, temp cycles, continuous ESD strike etc, the maximum leakage current is less than 10uA.

**ESD Clamping Test**

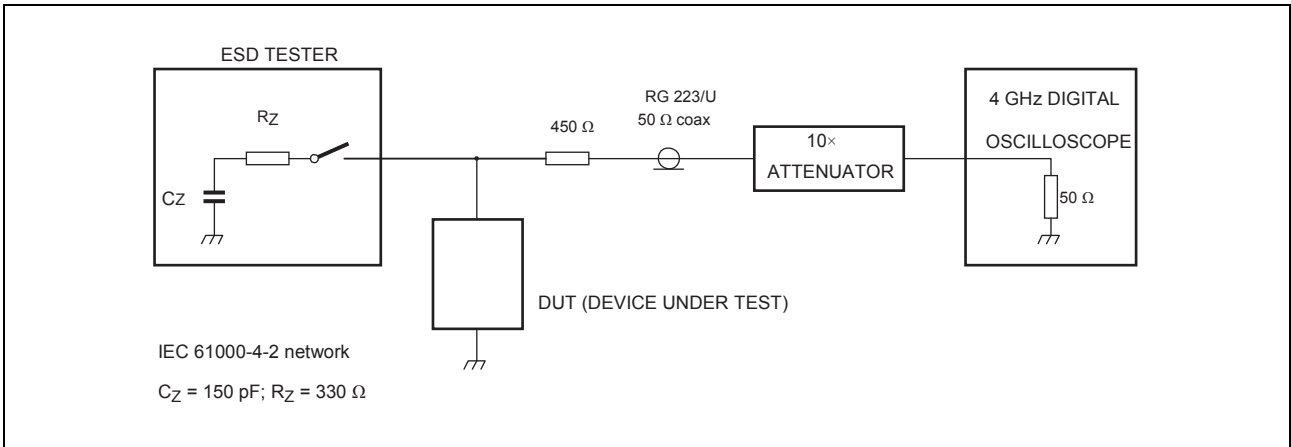

**Typical Characteristics**

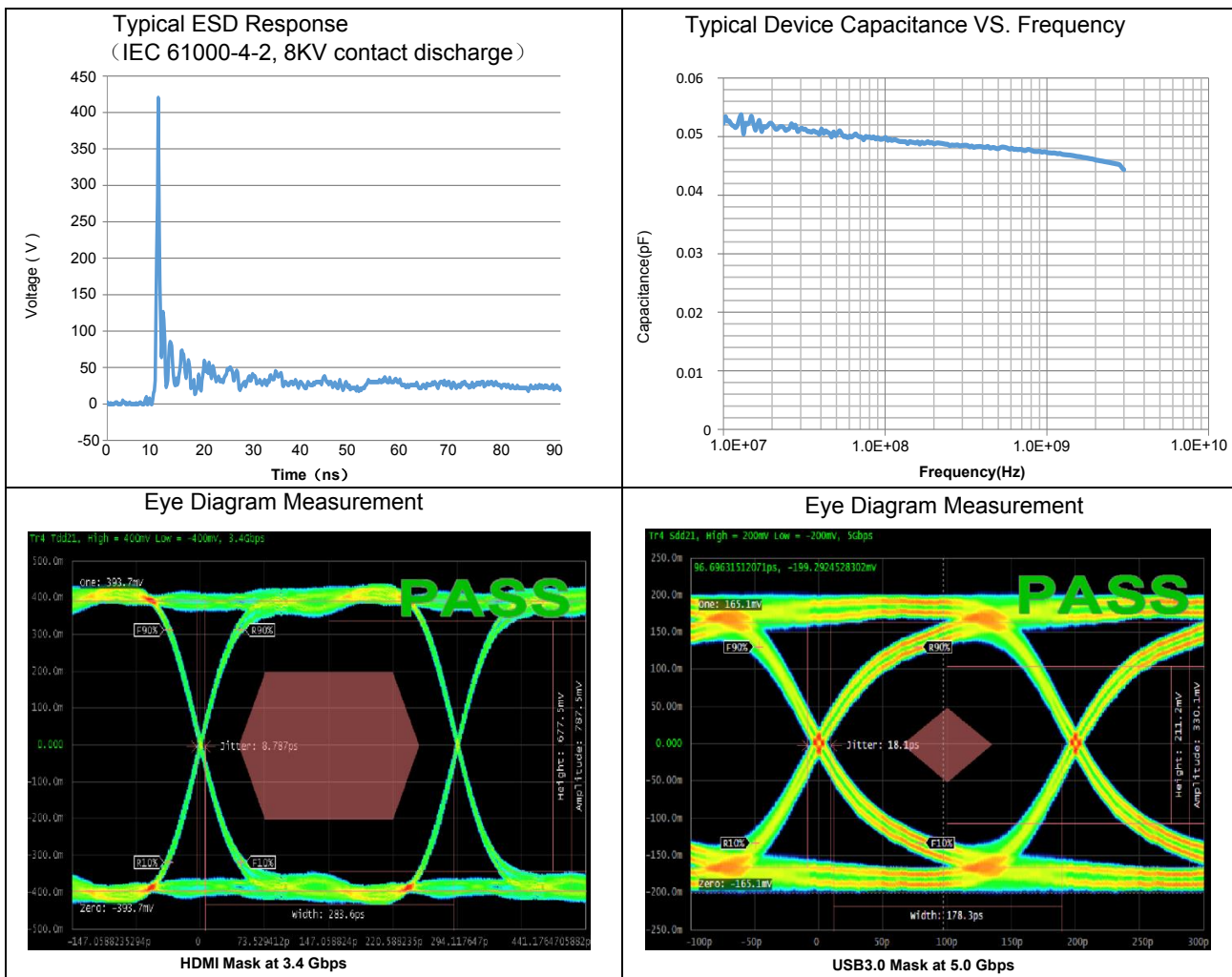

## Product Dimension

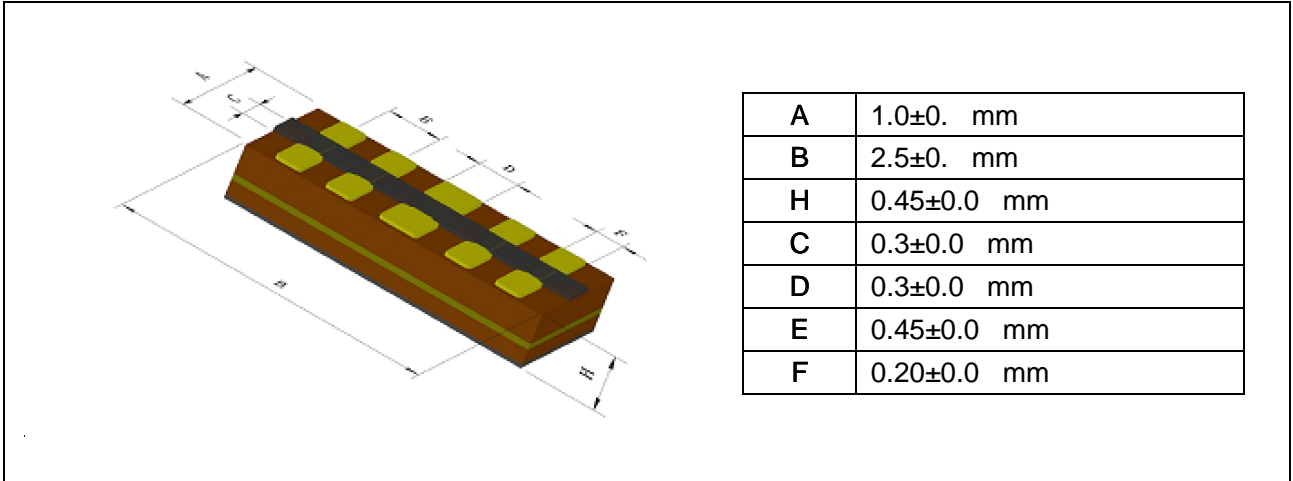

## PAD Dimension

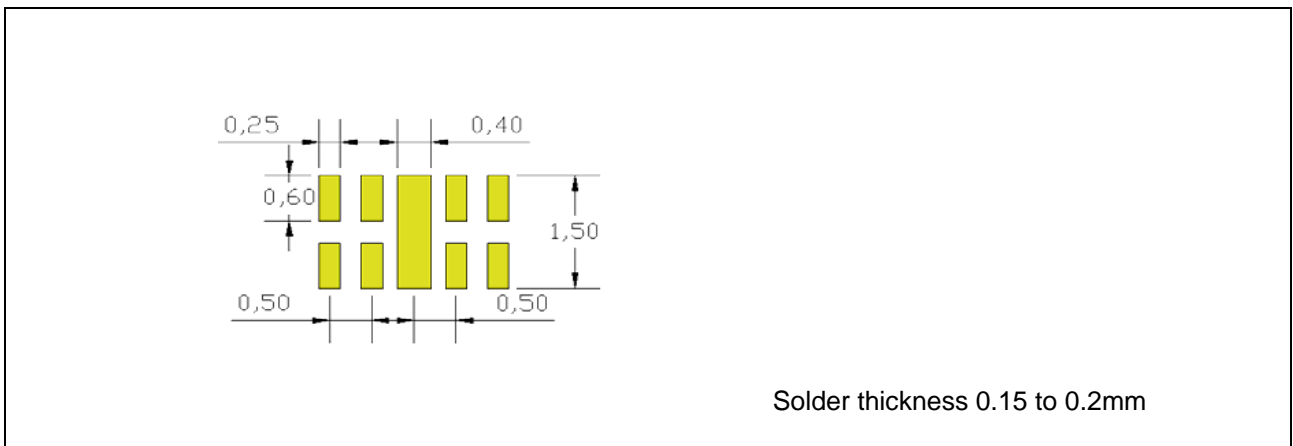

## Ordering information

Order code	Package	Packaging option	Base quantity	Packaging specification
CESDPD2510UC5VB	2510	Tape and reel	3000pcs / reel	EIA STD RS-481

## Revision history

Date	Revision	Changes
23-May-2016	1.0	Initial release

## **CAUTION / WARNING**

Information in this document is believed to be accurate and reliable. However, CREATEK does not give any representations or warranties, expressed or implied, as to the accuracy or completeness of such information and shall have no liability for the consequences of use of such information.

Users should independently evaluate the suitability of and test each product selected for their own applications, and CREATEK assumes no liability whatsoever relating to the choice, selection or use of the CREATEK products and services described herein.

CREATEK reserves the right to change or update, without notice, any information contained in this publication; to change, without notice, the design, construction, processing, or specification of any product; and to discontinue or limit production or distribution of any product.

Information in this document supersedes and replaces all information previously supplied.

Products are not designed, authorized or warranted to be suitable for use in medical, military, aircraft, space or life support equipment, nor in applications where failure or malfunction of an CREATEK product can reasonably be expected to result in personal injury, death or severe property or environmental damage. CREATEK accepts no liability for inclusion and/or use of CREATEK products in such equipment or applications and therefore such inclusion and/or use is at the customer's own risk.

This document as well as the item(s) described herein may be subject to export control regulations. Export might require a prior authorization from national authorities.

Resale of CREATEK products with provisions different from the statements and/or technical features set forth in this document shall immediately void any warranty granted by CREATEK for the CREATEK product or service described herein and shall not create or extend in any manner whatsoever, any liability of CREATEK.

CREATEK expressly disclaims all implied warranties regarding the information contained herein, including, but not limited to, any implied warranties of merchantability or fitness for a particular purpose. CREATEK only obligations are those in the CREATEK Standard Terms and Conditions of Sale and in no case will CREATEK be liable for any incidental, indirect, or consequential damages arising from the sale, resale, use, or misuse of its products.

---

Specifications are subject to change without notice

© Copyright 2009, CREATEK Microelectronics

 CREATEK® is a registered trademark of CREATEK Microelectronics

All rights reserved