



ORIENT

Photo coupler

Product Data Sheet

Part Number: OR-MOC306X

Customer: _____

Date: _____

SHENZHEN ORIENT COMPONENTS CO ., LTD

Block A 3rd Floor No.4 Building, Tian'an Cyber Park, Huangge Rd, LongGang Dist, Shenzhen, GD

TEL: 0755-29681816

FAX: 0755-29681200

www.orient-opto.com

1. Features

- (1) High isolation voltage between input and output (Viso:5000 V rms)
- (2) 6pin zero-cross optoisolators triac driver output
- (3) High repetitive peak off-state voltage VDRM : Min. 600V
- (4) Compliance with EU REACH
- (5) High critical rate of rise of off-state voltage(dV/dt : MIN. 1000V /s)
- (6) Dual-in-line package : OR-MOC3061 / OR-MOC3062 / OR-MOC3063
- (7) Wide lead spacing package : OR-MOC3061M / OR-MOC3062M / OR-MOC3063M
- (8) Surface mounting package : OR-MOC3061S / OR-MOC3062S / OR-MOC3063S
- (9) Tape and reel packaging : OR-MOC3061S-TA1 /OR- MOC3062S-TA1 / OR-MOC3063S-TA1
- (10) Operating temperature -40 °C to +110 °C

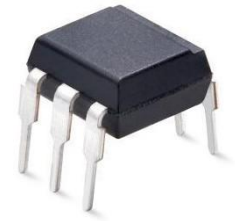

2. Description

The OR-MOC306X series of devices each consist of a GaAs infrared emitting diode optically coupled to a monolithic silicon zero voltage crossing photo triac.They are designed for use with a discrete power triac in the interface of logic systems , such as solid-state relays, industrial controls, motors, solenoids and consumer appliances.

3. Application Range

- (1)AC Motor Drives (2)AC Motor Starters (3)Static power switch
- (4)Lighting Controls (5)Solenoid/Valve Controls (6)Solid State Relays
- (7)Temperature Controls

4. Absolute Maximum Ratings (Ta=25°C)

Parameter		Symbol	Rateing	Unit
Input	Forward Current)	IF	50	mA
	Junction Temperature	TJ	125	°C
	Reverse Voltage	VR	6	V
	Power Dissipation	P	100	mW
Output	Off-State Output Terminal Voltage	V DRM	600	V
	Peak Repetitive Surge Current (PW=1ms, 120 pps)	ITSM	1	A
	Junction Temperature	TJ	125	°C
	Collector Power Dissipation	PC	150	mW
Total Power Dissipation		Ptot	250	mW
*Insulation Voltage		Viso	5000	Vrms
Working Temperature		Topr	-40 ~ + 110	°C
Deposit Temperature		Tstg	-55 ~ + 125	
*2 Soldering Temperature		Tsol	260	

Notes:

*1 AC for 1 minute, R.H.= 40 ~ 60% R.H. In this test, pins 1, 2&3 are shorted together, and pins 4, 6 are shorted together.

* 2 For 10 seconds

5. Electrical Optical Characteristics at Ta=25°C

Parameter		Symbol	Test Condition	Min	Typ.	Max	Unit	
Input	Forward Voltage	V_F	$I_F=20\text{mA}$	---	1.2	1.6	V	
	Reverse Current	I_R	$V_R=6\text{V}$	---	---	5	μA	
Output	1.Peak Blocking Current, Either Direction	I_{DRM}	$V_{\text{DRM}} = 600\text{V}$	---	---	500	nA	
	Peak On-State Voltage, Either Direction	V_{TM}	$I_{\text{TM}}=100\text{mA Peak}$	---	---	3.0	V	
	2.Critical rate of Rise of Off-State Voltage	dv/dt	$V_{\text{in}}=240\text{Vrms}$	1000	---	---	V/us	
Couple	3.Led Trigger Current, Current Required to Latch Output, Either Direction	OR-MOC3061	I_{FT}	Main Terminal Voltage = 3V	---	---	15	mA
		OR-MOC3062			---	---	10	
		OR-MOC3063			---	---	5	
	Holding Current, Either Direction		I_H		---	400	---	μA
ZERO CROSSING	Inhibit Voltage	V_{INH}	$I_F = \text{Rated } I_{\text{FT}}$, MT1-MT2 Voltage above which device will not trigger.	---	5	20	Volts	
	Leakage in Inhibited State	I_{DRM2}	$I_F = \text{Rated } I_{\text{FT}}$, Rated V_{DRM} , Off State	---	---	500	μA	

*1. Test voltage must be applied within dv/dt rating.

*2. This is static dv/dt. Commutating dv/dt is a function of the load-driving thyristor(s) only.

*3. All devices are guaranteed to trigger at an I_F value less than or equal to max I_{FT} .

Therefore, recommended operating I_F lies between max I_{FT} , 15 mA for OR-MOC3061, 10 mA for OR-MOC3062, 5 mA for OR-MOC3063, and absolute max I_F (50mA).



6. Order Information

Part Number

OR-MOC306XY-Z

Note

X = IFT Rank (1, 2, 3 or none)

Y = Lead form option (S, M or None)

Z = Tape and reel option (TA,TA1 or none).

* Halogen Free can be selected.

* VDE Code can be selected.

Option	Description	Packing quantity
None	Standard DIP-6	66 units per tube
M	Wide lead bend (0.4 inch spacing)	66 units per tube
S(TA)	Surface mount lead form (low profile) + TA tape & reel option	1000 units per reel
S(TA1)	Surface mount lead form (low profile) + TA1 tape & reel option	1000 units per reel

7. Naming Rule

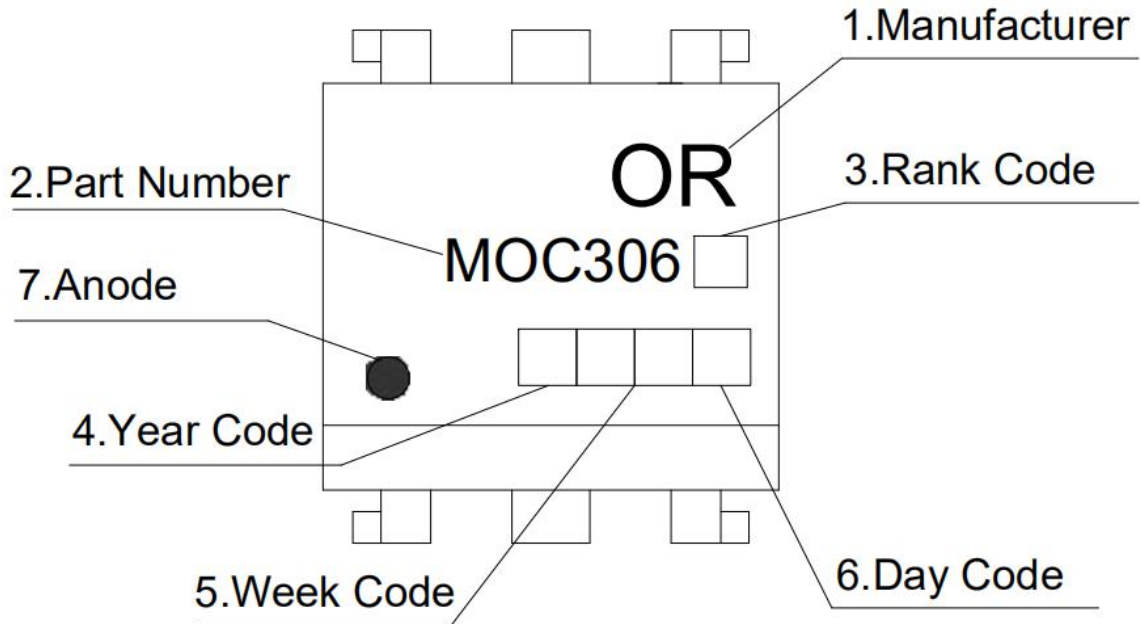

NOTE:

- (1) ORIENT.
- (2) MOC306□ denotes Device Part Number .
- (3) □ denotes IFT Rank Code ,1=MOC3061; 2=MOC3062; 3=MOC3063.
- (4) □ denotes Year code.
- (5) □□ denotes Week code.
- (6) □ denotes Day code.
- (7) ● denotes Anode

* If the photo coupler is Free from Halogen, there will be a ' G ' mark in the upper left corner.

* VDE Code can be selected.

8. Package Dimension

(1).OR-MOC306X

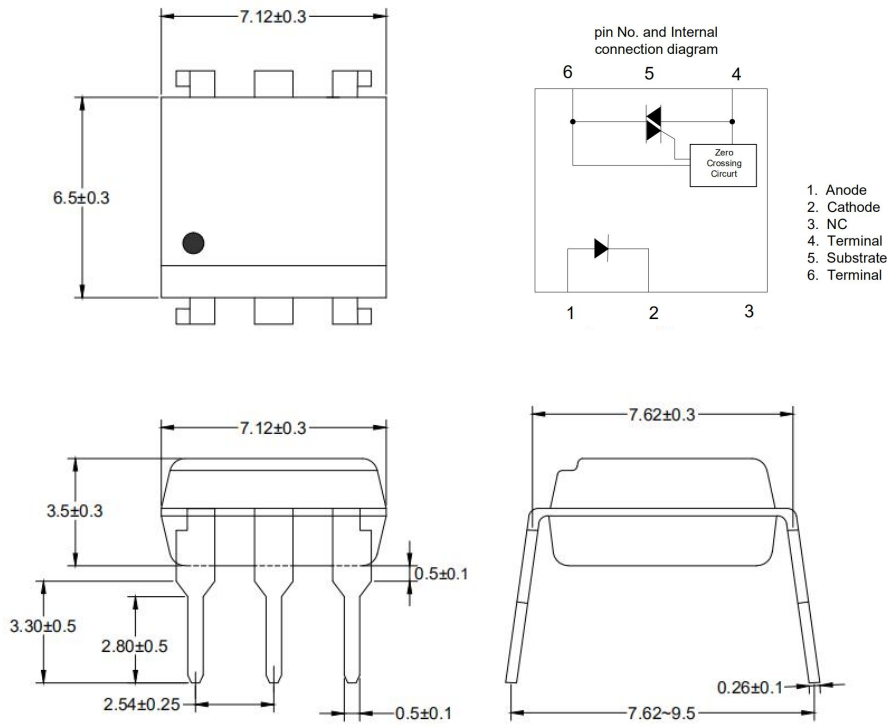

(2).OR-MOC306XM

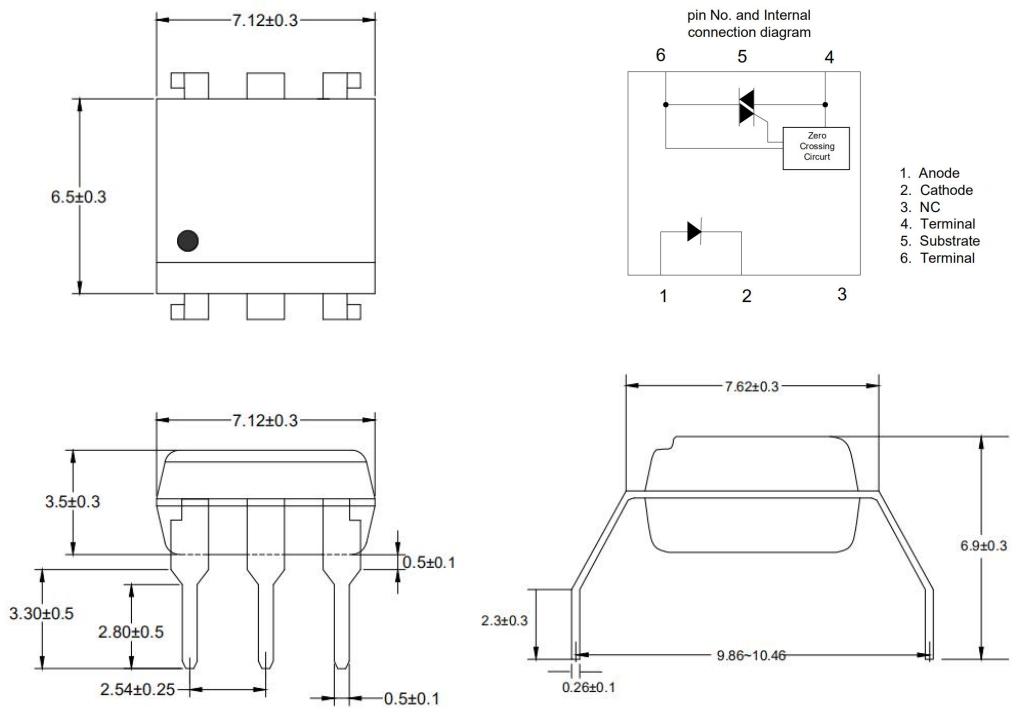

(3).OR-MOC306XS

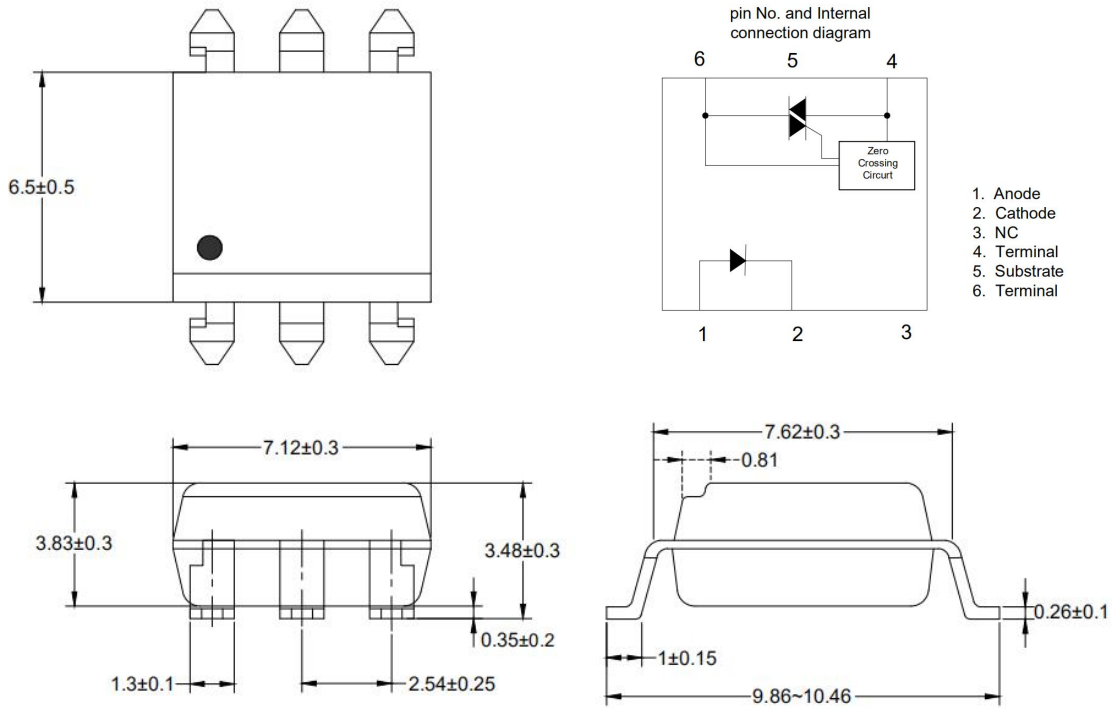

9. Taping Dimensions

(1).OR-MOC306XS-TA

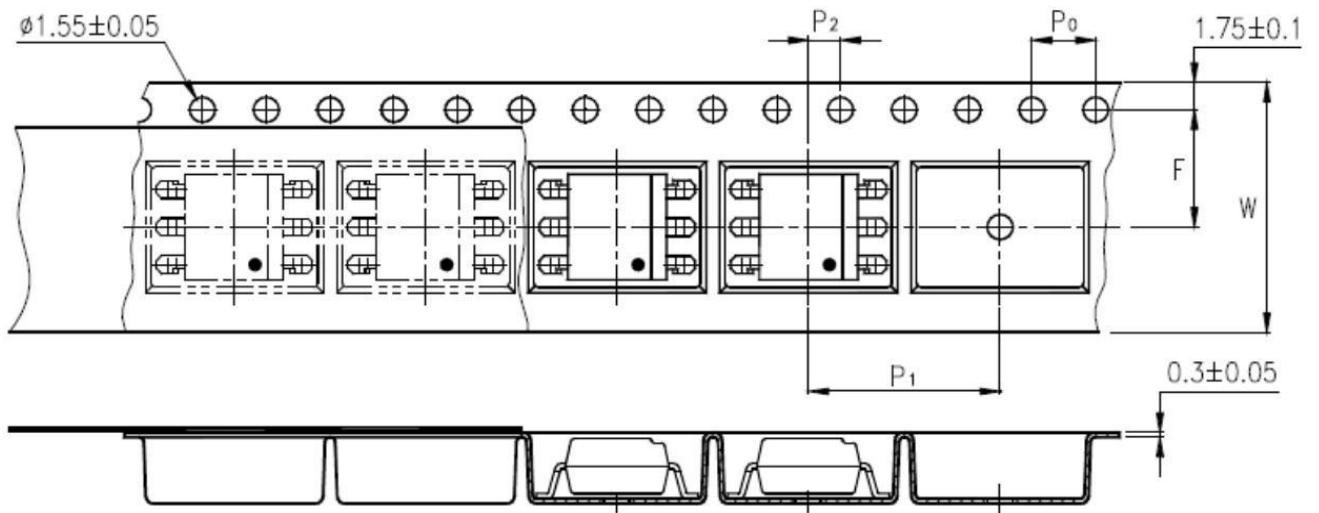

(2).OR-MOC306XS-TA1

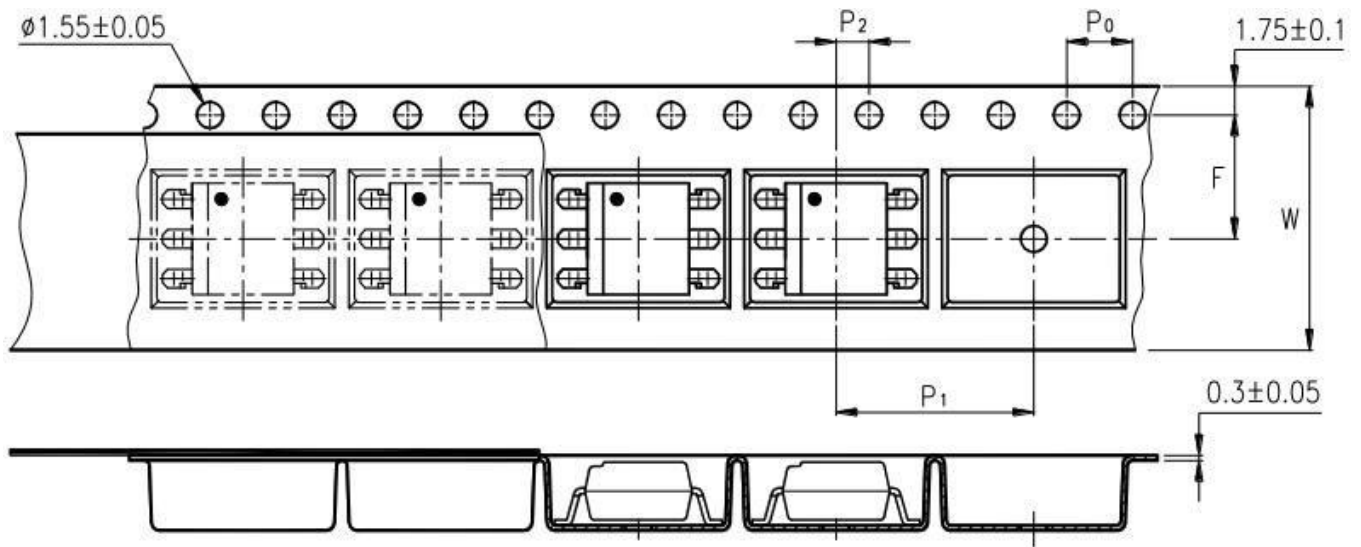

Description	Symbol	Dimension in mm (inch)
Tape wide	W	16±0.3 (0.63)
Pitch of sprocket holes	P ₀	4±0.1 (0.15)
Distance of compartment	F	7.5±0.1 (0.295)
	P ₂	2±0.1 (0.079)
Distance of compartment to compartment	P ₁	12±0.1 (0.472)

Package Type	OR-MOC306XS series(TA/TA1)
Quantities(pcs)	1000

10. Package Dimension

(1) package dimension

DIP/M type

Packing Information	
Packing type	Tube(Plug)
Qty per Tube	66
Small box (inner) Dimenaion	525*132*60mm
Max qty per small box	3300
Large box (Outer) Dimenaion	530*290*335mm
Max qty per large box	26400

SOP type

Packing Information	
Packing type	Reel type
Tape Width	16mm
Qty per Reel	1000
Small box (inner) Dimenaion	345*345*60mm
Max qty per small box	2000
Large box (Outer) Dimenaion	620x360x360mm
Max qty per large box	20000

(2)Packing Label Sample



1. MTL NO:Contents with "Order Information" in the specification.
2. LOT NO:The production cycle of the product.
3. BATCH:The CTR RANK of the product.
4. Quantity:Product packaging quantity.
5. Product Data: The data when product be made.

11. Reliability Test

N0.	Item	Condition	Quantity	Cycle	Reference Standards
1	RSH, Resistance to Solder Heat	260±5℃, 10s/cycle	22	3cycles	JESC22A-106
2	SD, Solderability	260±5℃, 2-3s/cycle	22	1cycle	JESD22-B102
3	TC, Temperature Cycle	H: 125℃ 15min ∫ 5min L: -55℃ 15min	77	300cycles	JESC22A-104
4	TS, Thermal Shock	H:100℃ 5min ∫ 15s L:-10℃ 5min	77	300cycles	JESC22A-106
5	LTSL, Low Temperature Storage	T:-55℃	77	1000h	JESD22-A119
6	HTSL, High Temperature Storage	T:125℃	77	1000h	JESC22A-103
7	THB, High Temperature High Humidity	T:85℃ RH: 85%	77	1000h	JESC22A-101
8	HTOL DC Operating Life	T: 110℃ IF=10mA VCC=5V	77	1000h	MIL-STD-750 Method 1037
9	ESD-HBM Human Body Model ESD	Ta=25° C, Reference JESD22-A114	6	1cycle	JESD22-A114

12. Temperature Profile Of Soldering

(1).IR Reflow soldering (JEDEC-STD-020C compliant)

One time soldering reflow is recommended within the condition of temperature and time profile shown below. Do not solder more than three times.

Profile item	Conditions
Preheat	
- Temperature Min (T_{Smin})	150°C
- Temperature Max (T_{Smax})	200°C
- Time (min to max) (ts)	90±30 sec
Soldering zone	
- Temperature (TL)	217°C
- Time (t_L)	60 sec
Peak Temperature(T_P)	260°C
Ramp-up rate	3°C / sec max.
Ramp-down rate	3~6°C / sec

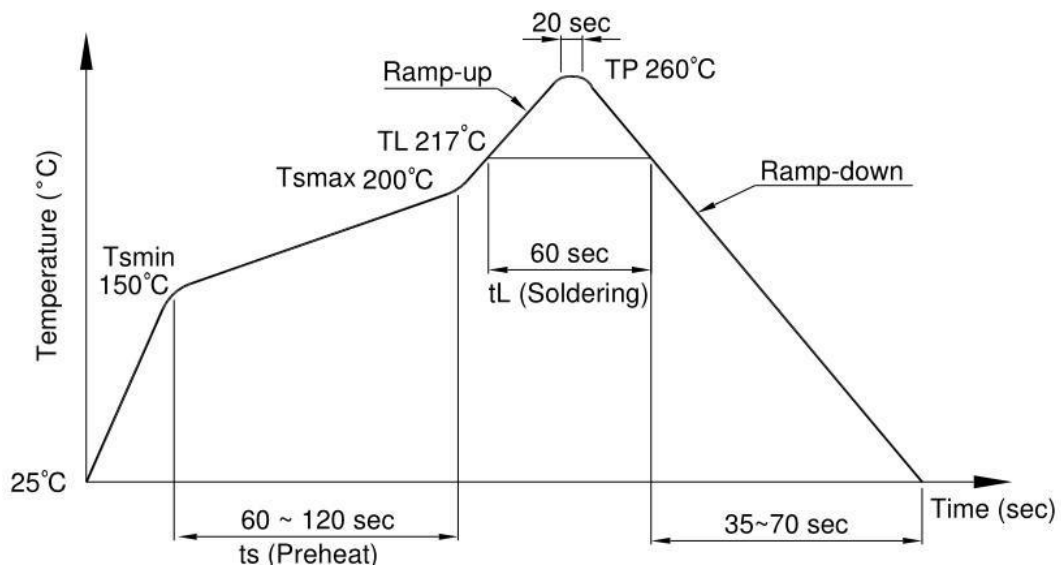

(3) .Wave soldering (JEDEC22A111 compliant)

One time soldering is recommended within the condition of temperature.

Temperature	260+0/-5°C
Time	10 sec
Preheat temperature	5 to 140°C
Preheat time	30 to 80 sec

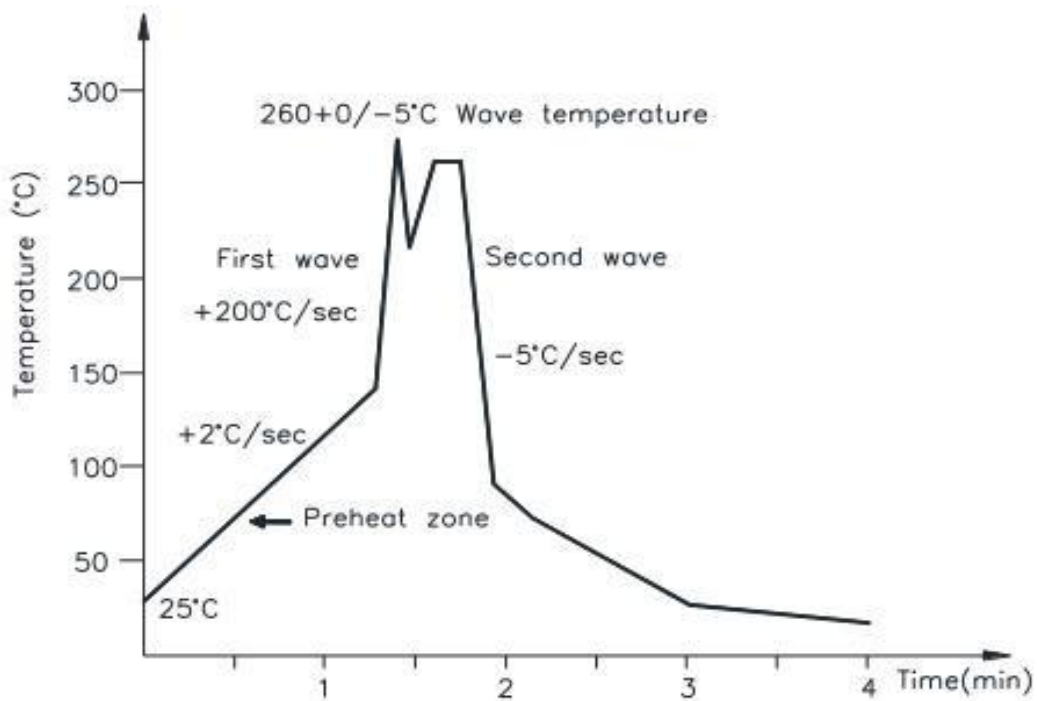

(3).Hand soldering by soldering iron

Allow single lead soldering in every single process. One time soldering is recommended.

Temperature	380+0/-5°C
Time	3 sec max

13. RRECOMMENDED FOOT PRINT PATTERNS (MOUNT PAD)

Unit: mm

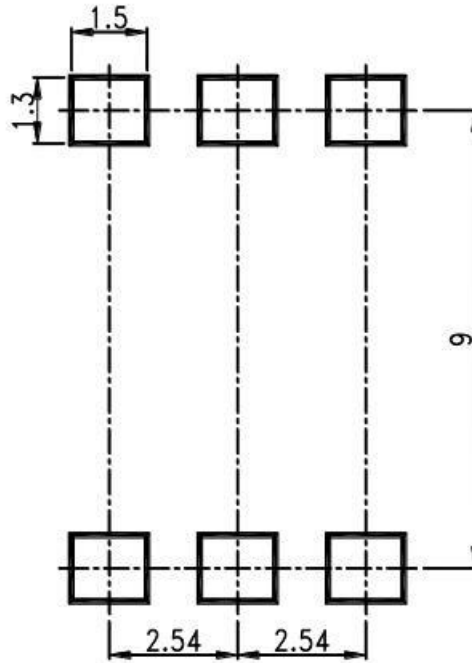

14. CHARACTERISTICS CURVES (TYPICAL PERFORMANCE)

Fig.1 Forward current vs Ambient temperature

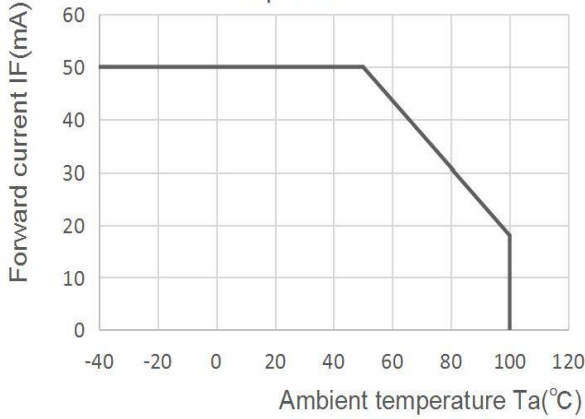

Fig.2 On-state current ITM (A) vs. Ambient temperature

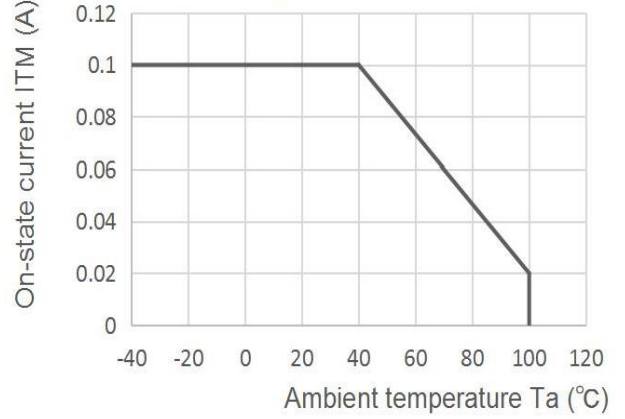

Fig.3 Minimum Trigger Current vs. Ambient temperature

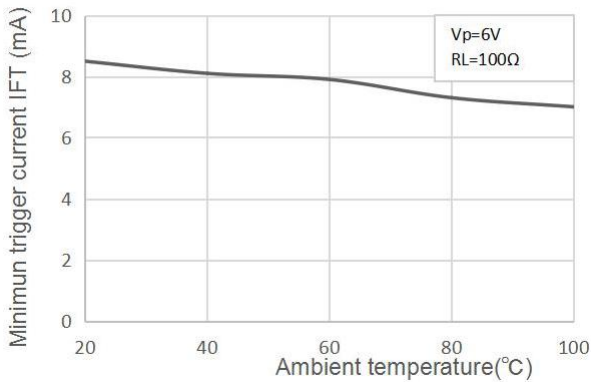

Fig.4 Forward current vs. Forward voltage

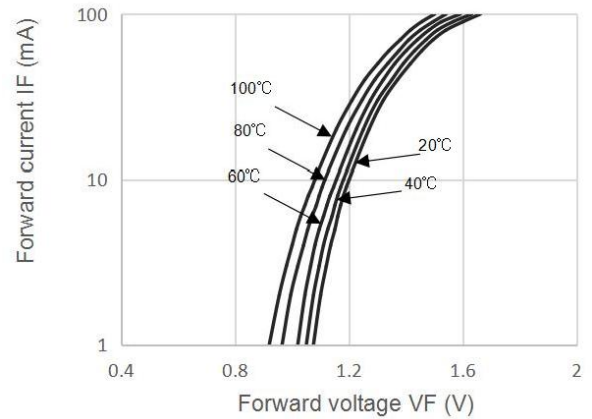

Fig.5 On-state voltage VT vs. Ambientn temperature

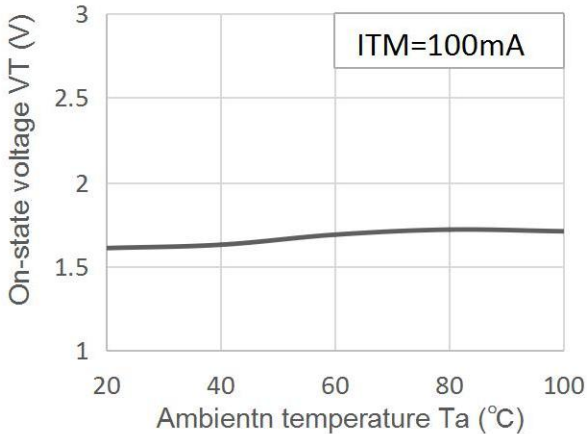

Fig.6 Holding current IH vs. Ambient temperature

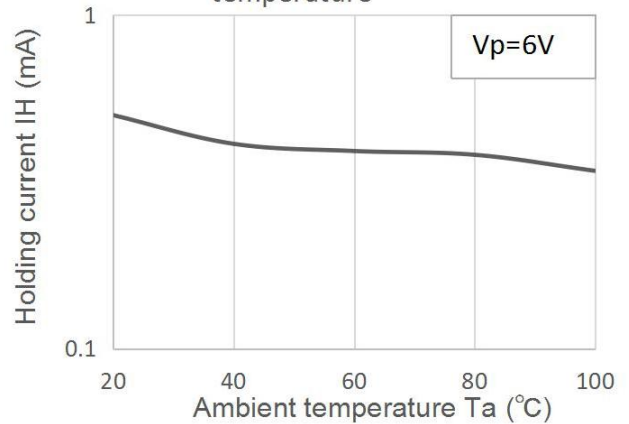

Fig.7 Repetitive peak off-state current vs. Temperature

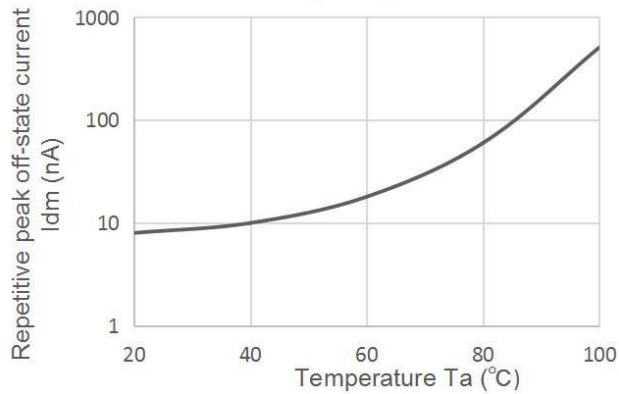
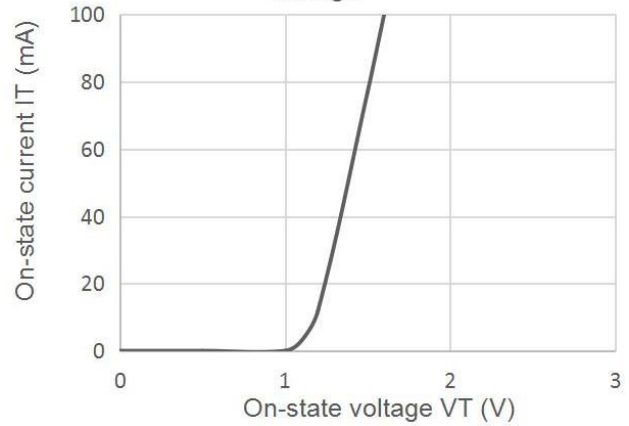

Fig.8 On-state current vs. On-state voltage



Basic Operation Circuit Medium/High Power Triac Drive Circuit

